

**VERSOL**  
MÁQUINA EFICIENTE PARA SUS PROYECTOS

**FPZ**  
BLOWER TECHNOLOGY

# SERIES R-MD MOR



**IE2 VERSION**

## TECHNICAL CHARACTERISTICS

- Aluminium alloy construction
- High efficiency impeller

## OPTIONS

- Special Voltages (IEC 60038)
- Surface treatments
- Increased seal version

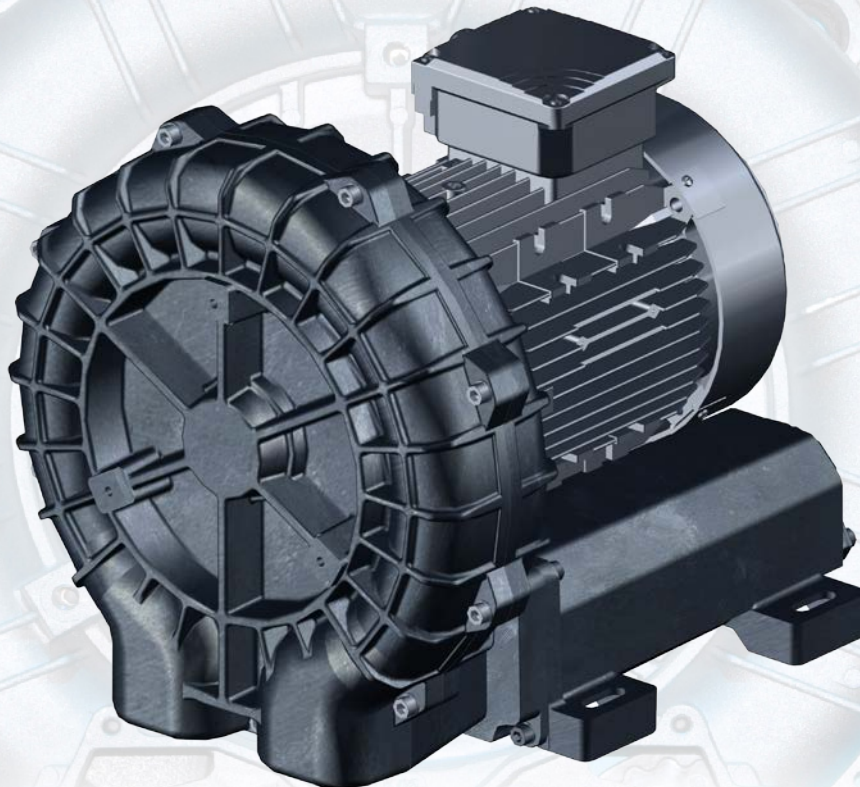

Data sheet

LATERAL CHANNEL BLOWERS-EXHAUSTERS

COMPANY WITH QUALITY MANAGEMENT  
SYSTEM CERTIFIED BY DNV  
= ISO 9001:2008 =



### PRESSURE

Model	N	N	Q max	Q max	$\Delta P$ max	$\Delta P$ max	Leq <sup>1</sup>	Leq <sup>1</sup>	Weight <sup>2</sup> max [kg]
	2900 rpm [kW]	3500 rpm [kW]	2900 rpm [m <sup>3</sup> /h]	3500 rpm [m <sup>3</sup> /h]	2900 rpm [hPa](mbar)	3500 rpm [hPa](mbar)	2900 rpm (Lp) [dB(A)]	3500 rpm (Lp) [dB(A)]	
R20-MD	<b>0,75</b>	0,9	58	70	300	250	66	66	20
	<b>1,1</b>	1,3	58	70	400	400	66,5	66,5	21,5
R30-MD	<b>1,1</b>	1,3	89	108	350	300	69,2	72,2	25
	<b>1,5</b>	1,75	89	108	425	400	69,7	72,7	26

### VACUUM

Model	N	N	Q max	Q max	$\Delta P$ max	$\Delta P$ max	Leq <sup>1</sup>	Leq <sup>1</sup>	Weight <sup>2</sup> max [kg]
	2900 rpm [kW]	3500 rpm [kW]	2900 rpm [m <sup>3</sup> /h]	3500 rpm [m <sup>3</sup> /h]	2900 rpm [hPa](mbar)	3500 rpm [hPa](mbar)	2900 rpm (Lp) [dB(A)]	3500 rpm (Lp) [dB(A)]	
R20-MD	<b>0,75</b>	0,9	58	70	300	250	65	68	20
	<b>1,1</b>	1,3	58	70	-	350	66	68,5	21,5
R30-MD	<b>1,1</b>	1,3	89	108	300	300	65,7	68,7	25
	<b>1,5</b>	1,75	89	108	350	350	66,2	69,2	26

 **ELECTRIC MOTORS IE2:** 3phase motor only, starting from 0,75KW

### INSTALLATION

- For proper use, the blower should be equipped with INLET FILTER and Flow Relief VALVE; other accessories available on request.
- Ambient temperature from -15° to +40°C (+5° to +104° F).
- Specifications subject to change without notice.
- Before installation read carefully all instructions.

<sup>1</sup> Noise measured at 1 m distance with inlet and outlet ports piped, in accordance to ISO 3744.

<sup>2</sup> Value refers to the weight of the machine with 3 Phase motor if MOR range, without motor if GOR or GVR range.

N: Installed motor power

Q: Flow rate

$\Delta P$ : Differential pressure

Leq: Noise level

### PRESSURE

#### 2900 rpm (50 Hz)

#### 3500 rpm (60 Hz)

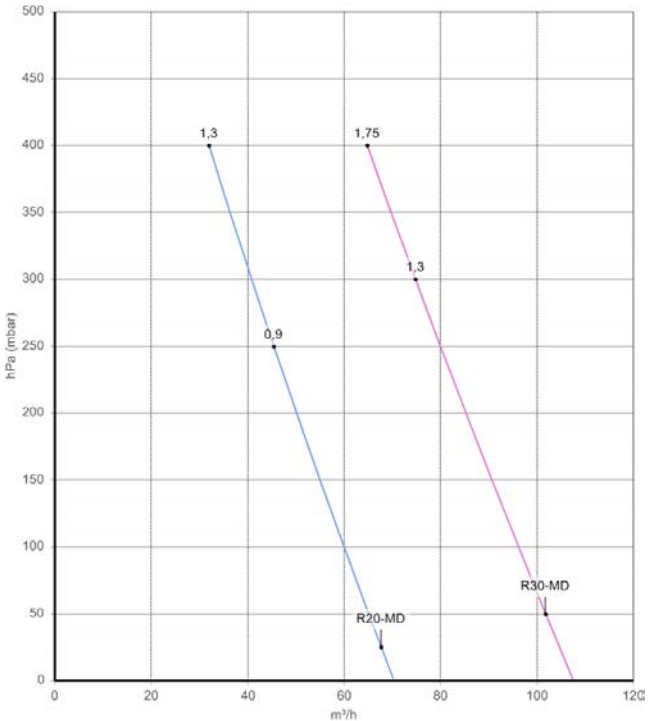
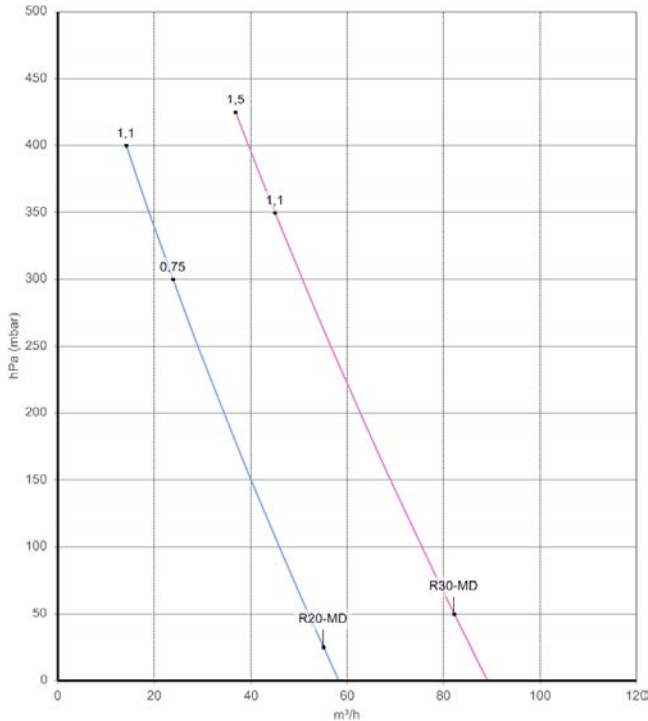

FLOW RATE

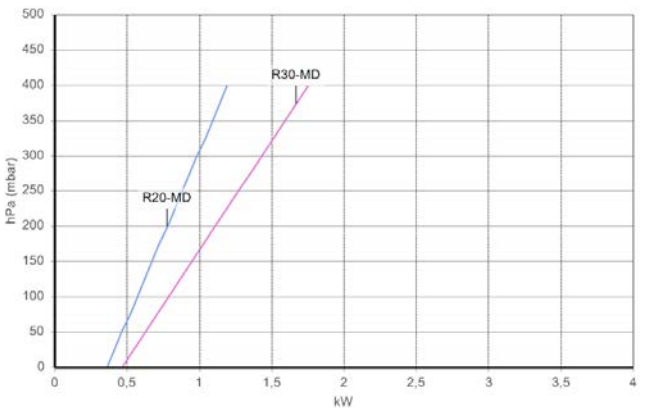
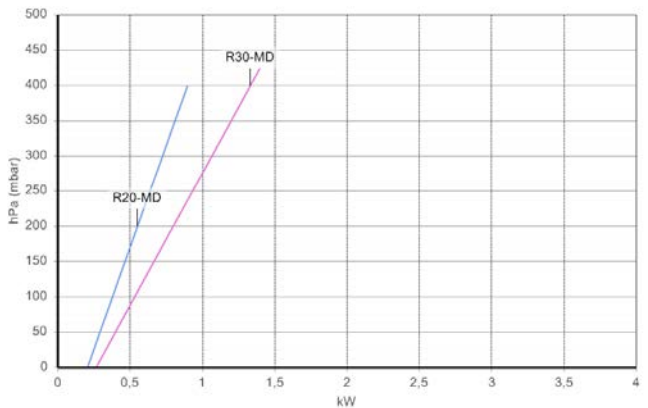

ABSORBED POWER

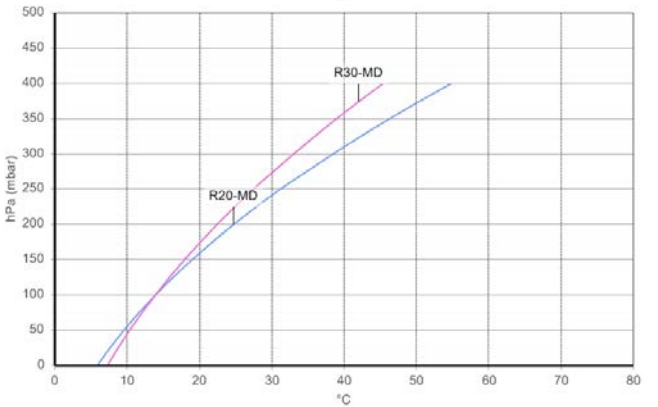
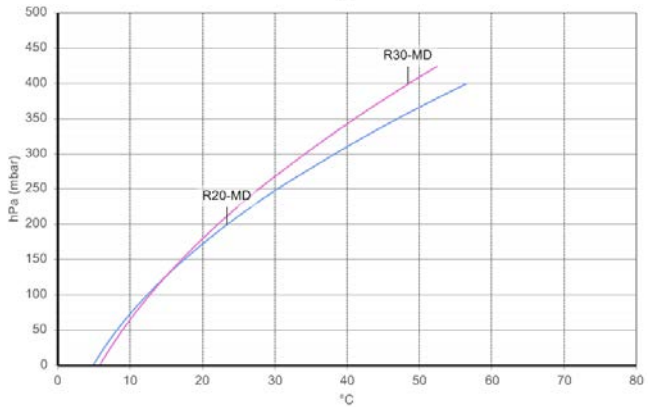

TEMPERATURE INCREASE

Curves refer to air at 20°C (68° F) temperature and 1013 mbar (29.92 In Hg) atmospheric pressure (abs) measured at inlet port.  
 Values for flow, power consumption and temperature rise: ±10% tolerance.  
 Data can change without prior notice.

### VACUUM

#### 2900 rpm (50 Hz)

#### 3500 rpm (60 Hz)

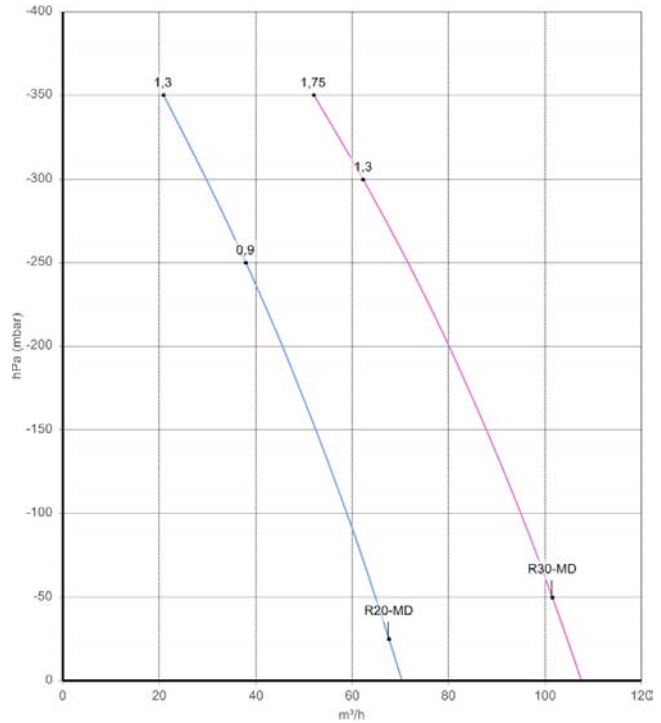
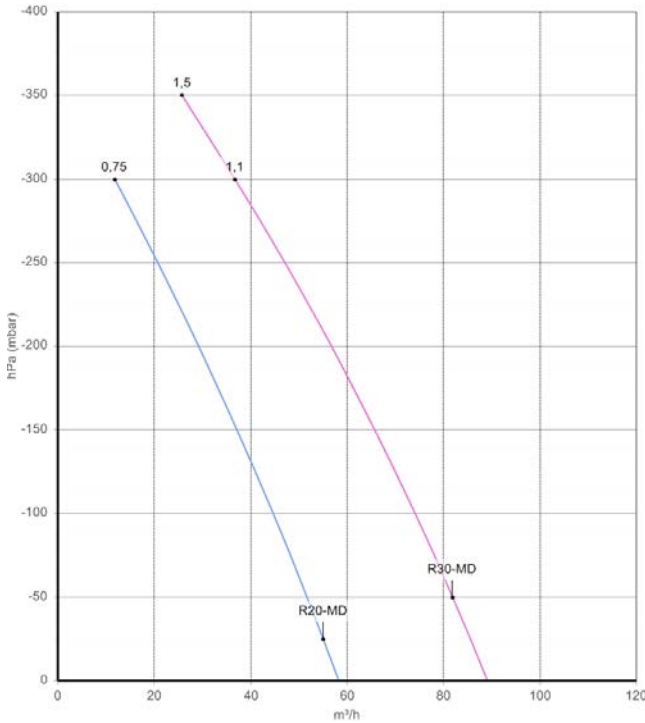

FLOW RATE

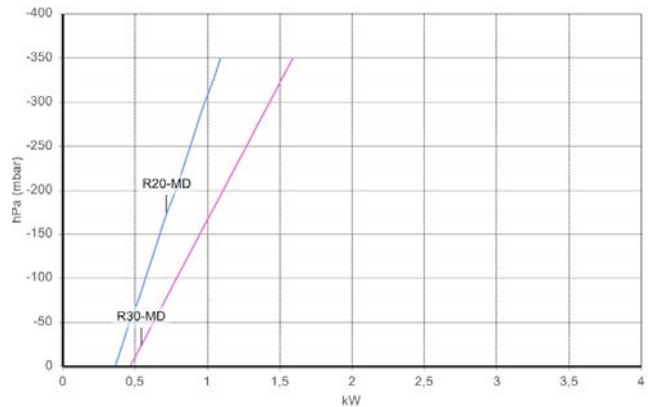
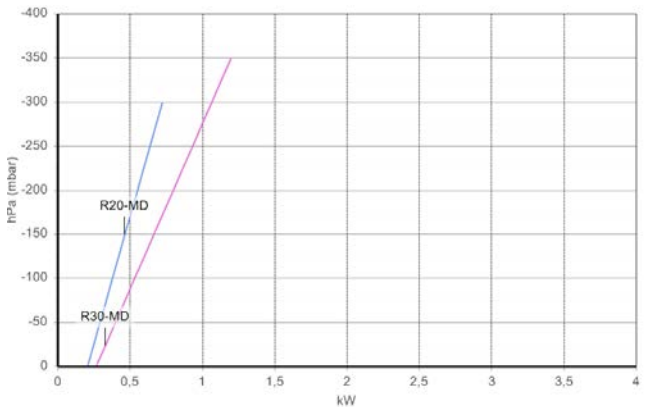

ABSORBED POWER

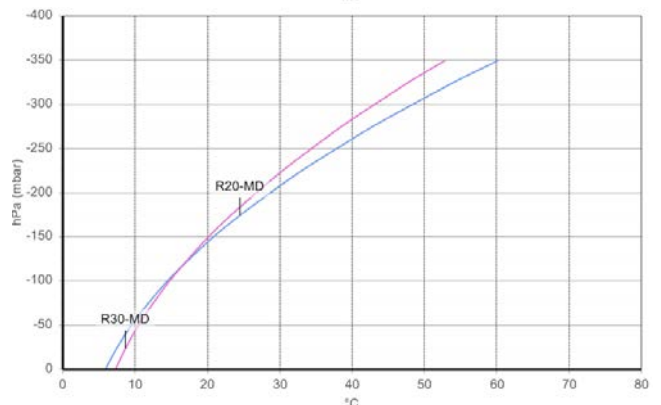
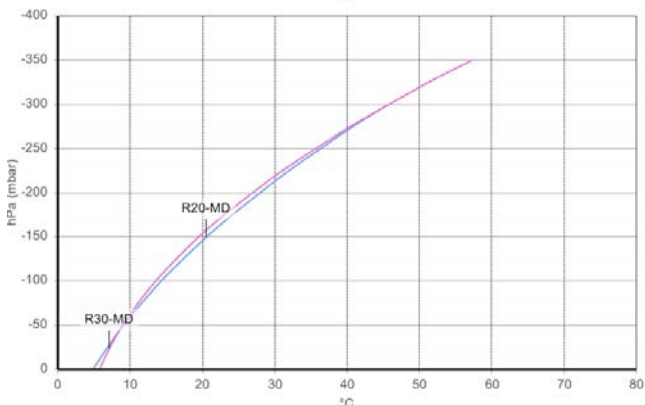

TEMPERATURE INCREASE

Curves refer to air at 20°C (68° F) temperature, measured at inlet port and 1013 mbar (29.92 In Hg) atmospheric backpressure (abs).  
 Values for flow, power consumption and temperature rise: ± 10% tolerance.  
 Data can change without prior notice.



## DIMENSIONS (R20-MD/R30-MD/)

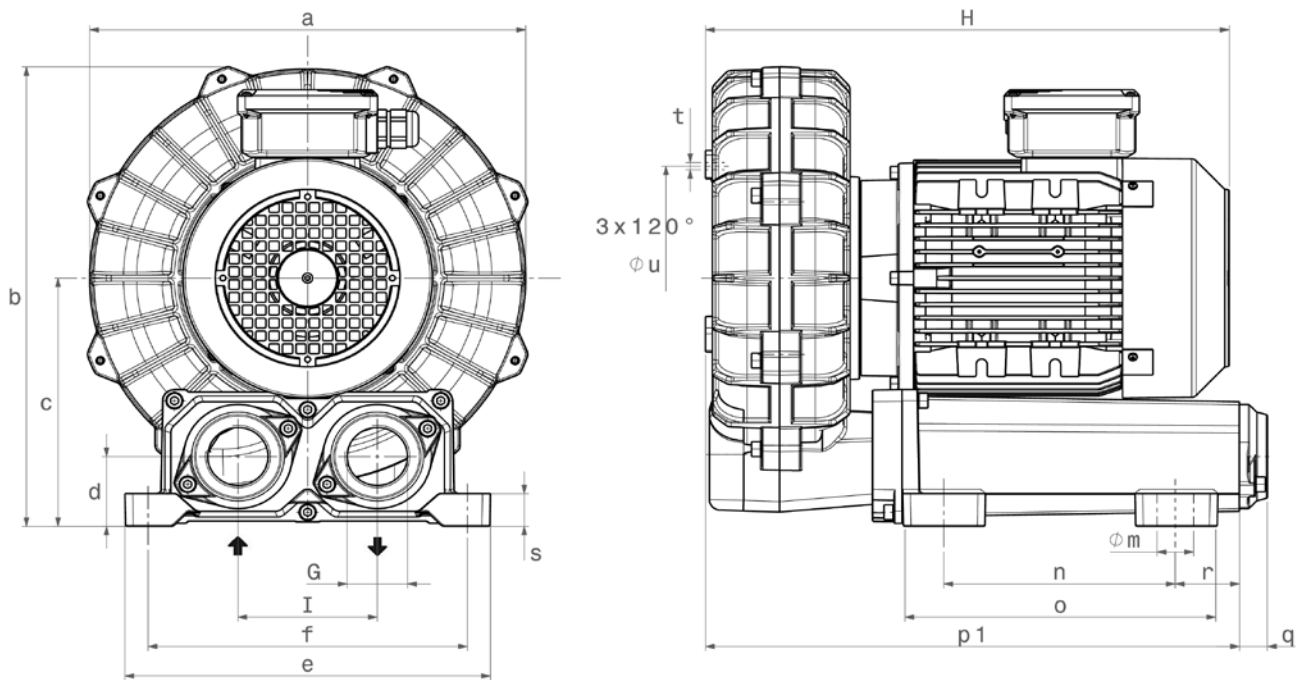

Dimensions in mm - FOR REFERENCE ONLY

Model	a	b	c	d	e	f
R20-MD	285	310	167	45	230	210
R30-MD	318	347	187	45	230	210

Model	G	H	i	m	n	o
R20-MD	G 1" 1/4	338	90	10	150	195
R30-MD	G 1" 1/4	366	90	10	150	195

Model	p1	q	r	s	t	u
R20-MD	345	18	45	20	M6	150
R30-MD	354	18	45	20	M6	180

# 40DH-MD MOR

## VERSION EU

### TECHNICAL CHARACTERISTICS

- Aluminium alloy construction
- High efficiency impeller

### OPTIONS

- Special Voltages (IEC 60038)
- Surface treatments
- Increased seal version

Data sheet

LATERAL CHANNEL BLOWERS-EXHAUSTERS

COMPANY WITH QUALITY MANAGEMENT  
SYSTEM CERTIFIED BY DNV  
= ISO 9001:2008 =



### PRESSURE

Model	N 2900 rpm [kW]	N 3500 rpm [kW]	Q max 2900 rpm [m³/h]	Q max 3500 rpm [m³/h]	ΔP max 2900 rpm [hPa] (mbar)	ΔP max 3500 rpm [hPa] (mbar)	Leq <sup>1</sup> 2900 rpm (Lp) [dB(A)]	Leq <sup>1</sup> 3500 rpm (Lp) [dB(A)]	Weight <sup>2</sup> max [kg]
40DH-MD	2,2	2,55	140	165	400	350	71,7	74,7	34
	3	3,45	140	165	500	500	72	75	38

### VACUUM

Model	N 2900 rpm [kW]	N 3500 rpm [kW]	Q max 2900 rpm [m³/h]	Q max 3500 rpm [m³/h]	ΔP max 2900 rpm [hPa] (mbar)	ΔP max 3500 rpm [hPa] (mbar)	Leq <sup>1</sup> 2900 rpm (Lp) [dB(A)]	Leq <sup>1</sup> 3500 rpm (Lp) [dB(A)]	Weight <sup>2</sup> max [kg]
40DH-MD	2,2	2,55	140	165	350	350	72	75	34
	3	3,45	140	165	-	-	-	-	38

### INSTALLATION

- For proper use, the blower should be equipped with INLET FILTER and Flow Relief VALVE; other accessories available on request.
- Ambient temperature from -15° to +40°C (+5° to +104° F).
- Specifications subject to change without notice.
- Before installation read carefully all instructions.

<sup>9</sup> Noise measured at 1 m distance with inlet and outlet ports piped, in accordance to ISO 3744.

<sup>10</sup> Value refers to the weight of the machine with 3 Phase motor if MOR range, without motor if GOR or GVR range.

N: Installed motor power

Q: Flow rate

ΔP: Differential pressure

Leq: Noise Level

**PRESSURE**

**2900 rpm (50 Hz)**

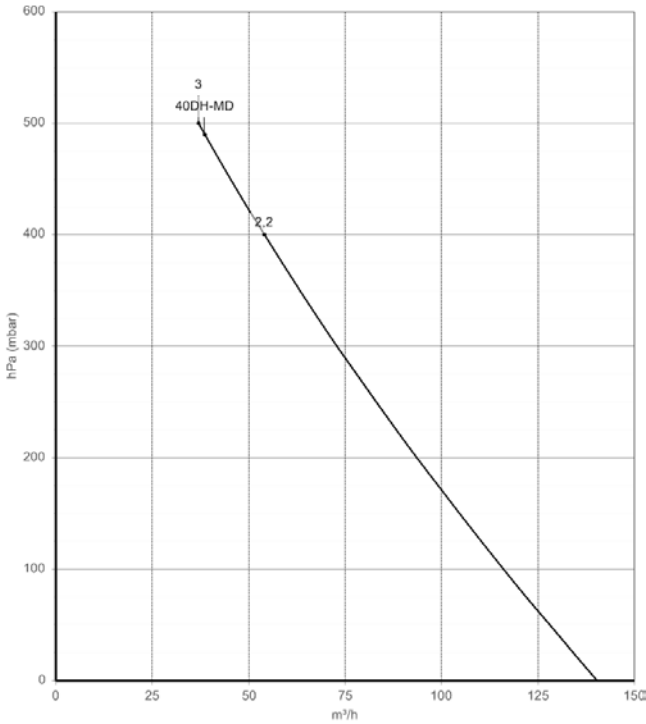

**3500 rpm (60 Hz)**

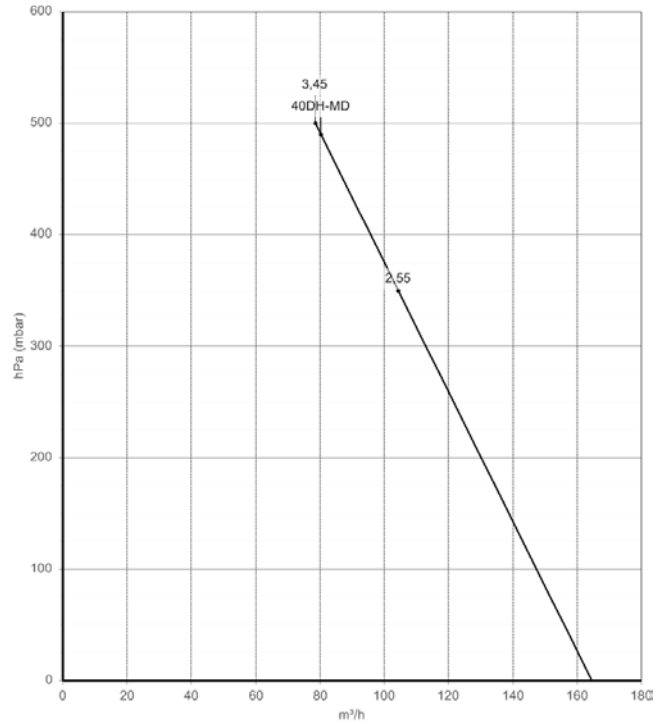

FLOW RATE

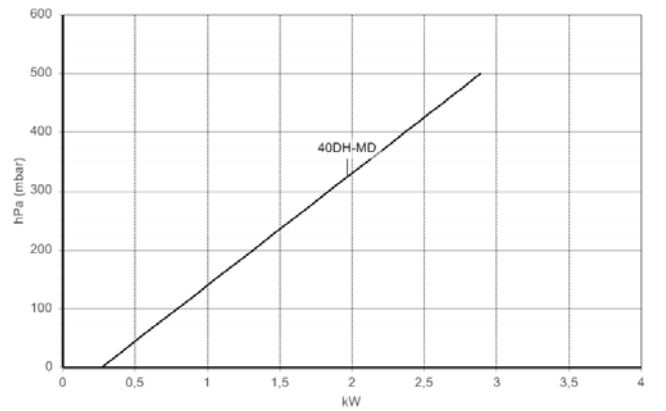
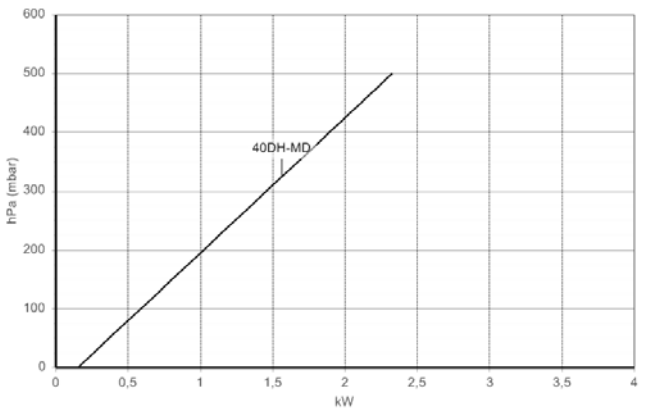

ABSORBED POWER

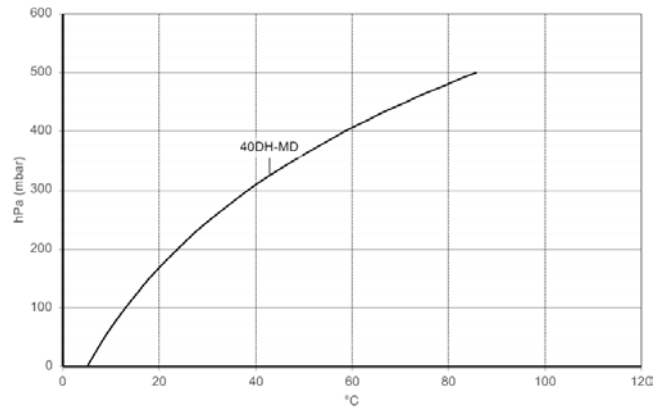
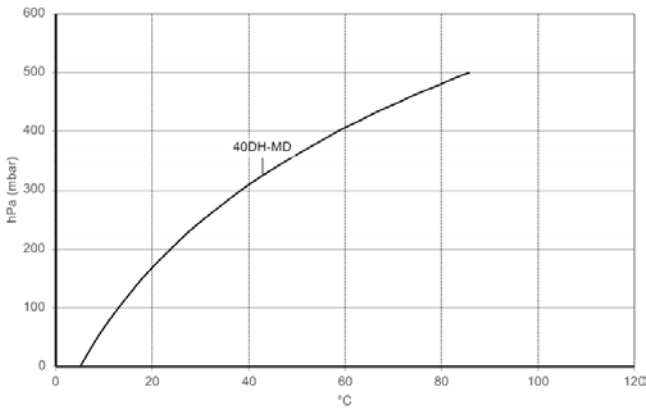

TEMPERATURE INCREASE

Curves refer to air at 20°C (68° F) temperature and 1013 mbar (29.92 In Hg) atmospheric pressure (abs) measured at inlet port.  
Values for flow, power consumption and temperature rise: ±10% tolerance.  
Data can change without prior notice.



## VACUUM

2900 rpm (50 Hz)

3500 rpm (60 Hz)

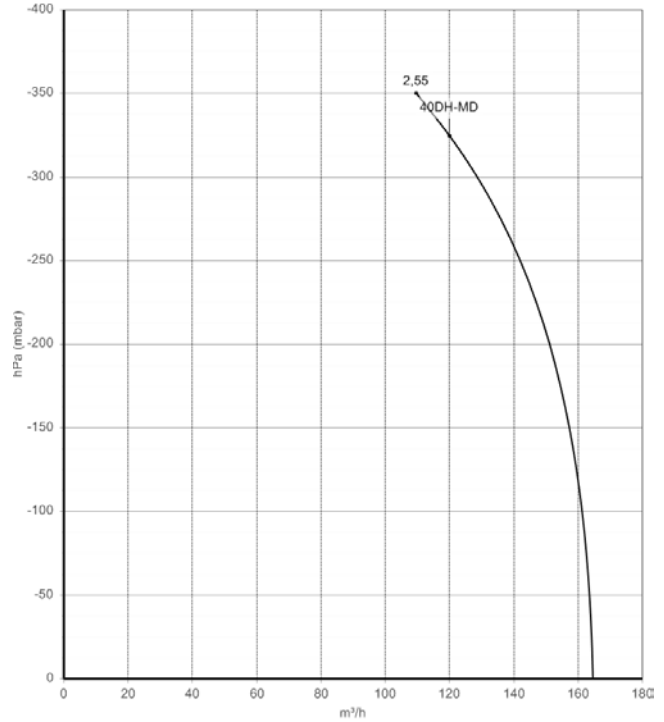
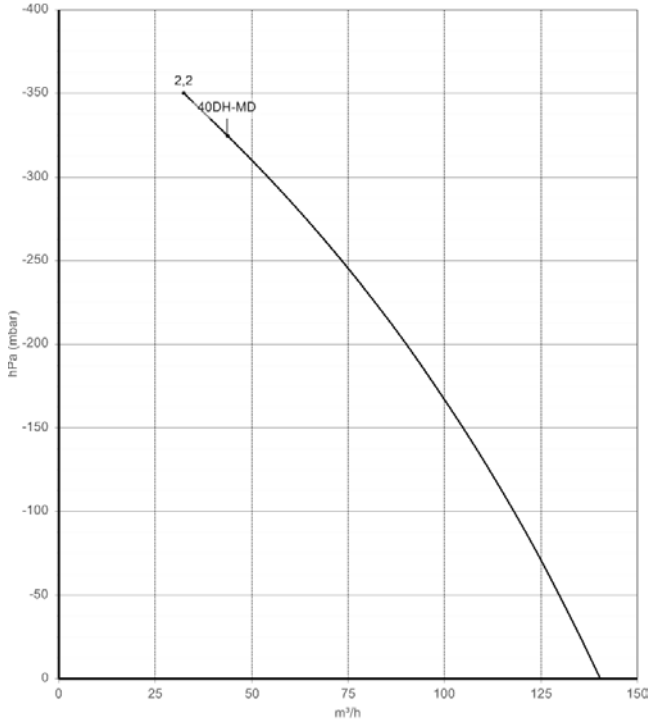

FLOW RATE

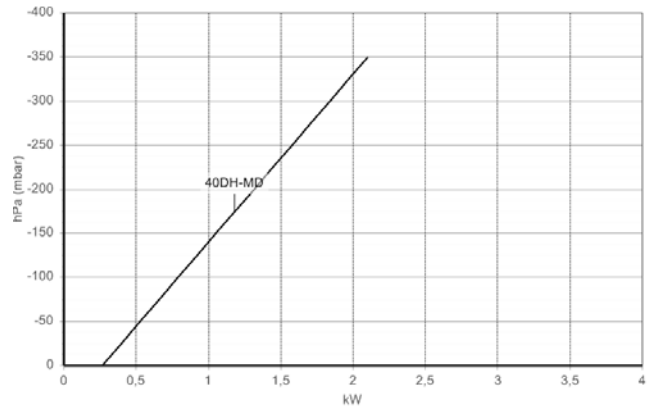
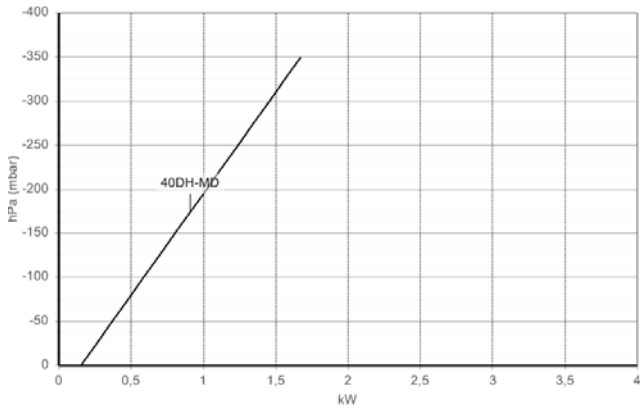

ABSORBED POWER

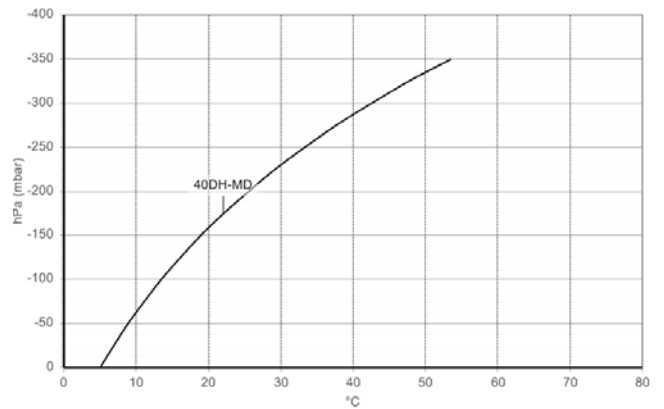
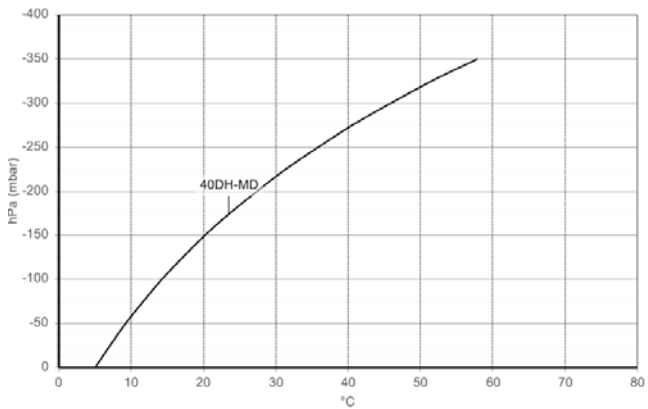

TEMPERATURE INCREASE

Curves refer to air at 20°C (68° F) temperature, measured at inlet port and 1013 mbar (29.92 In Hg) atmospheric backpressure (abs).  
 Values for flow, power consumption and temperature rise: ± 10% tolerance.  
 Data can change without prior notice.

# SERIES MD – RANGE MOR

EU VERSION

## DIMENSIONS (40DH-MD)

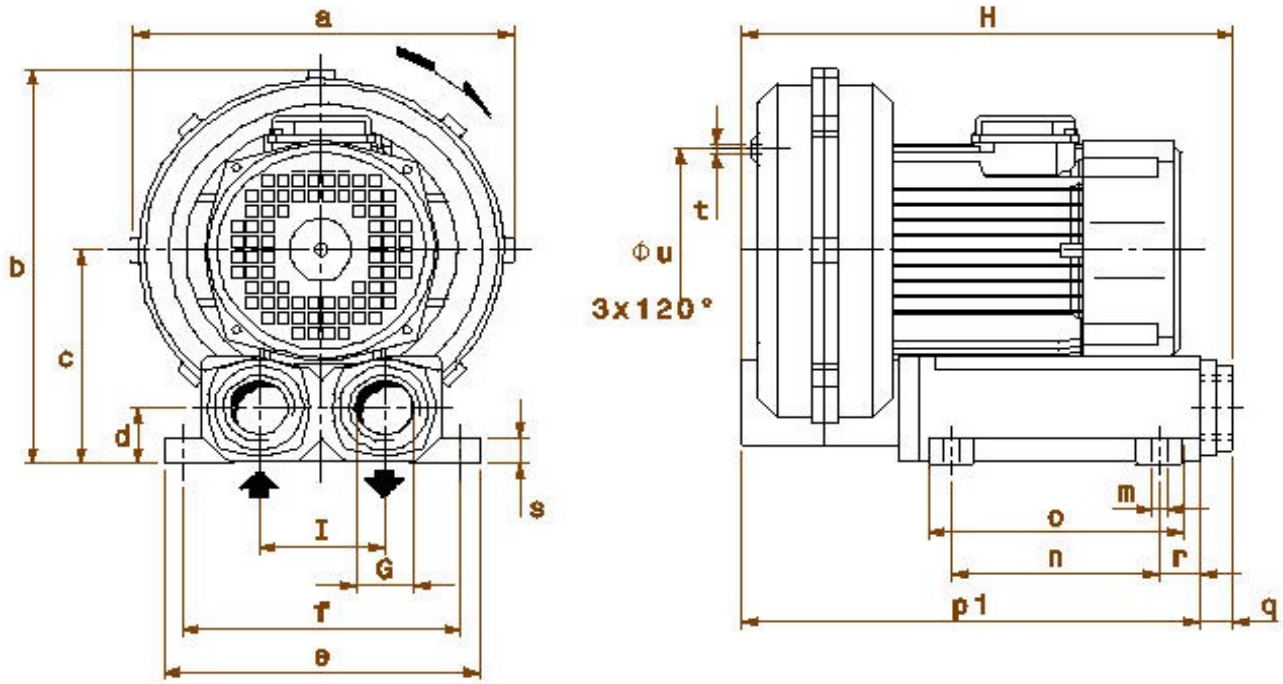

Model	a	b	c	d	e	f
40DH-MD	350	370	195	53	245	245

Model	G	H	i	m	n	o
40DH-MD	G 1"1/2	430	105	10	185	235

Model	p1	q	r	s	t	u
40DH-MD	440	18	55	20	M8	225

Dimensions in mm - FOR REFERENCE ONLY

**FPZ, Inc**

Saukville, Wisconsin  
USA  
usa@fpz.com

**FPZ Espana & Portugal**

Barcelona  
Espana  
mila.lozano@fpz.com

**FPZ France S.a.r.l.**

St. Priest  
France  
france@fpz.com

**HEADQUARTERS**

**FPZ S.p.A.**

Concorezzo (MB)  
Italy  
info@fpz.com

**FPZ México/LA**

Zapopan, Jalisco  
México  
mexico@fpz.com

**FPZ UK**

Andover, Hampshire  
United Kingdom  
uk@fpz.com

**FPZ Austria & Germany**

Krems  
Austria  
vertrieb@fpz.com