



SERIES K-TS MOR

EU VERSION

TECHNICAL CHARACTERISTICS

- Aluminium alloy construction
- High efficiency impeller

OPTIONS

- Special Voltages (IEC 60038)
- Surface treatments
- Increased seal version

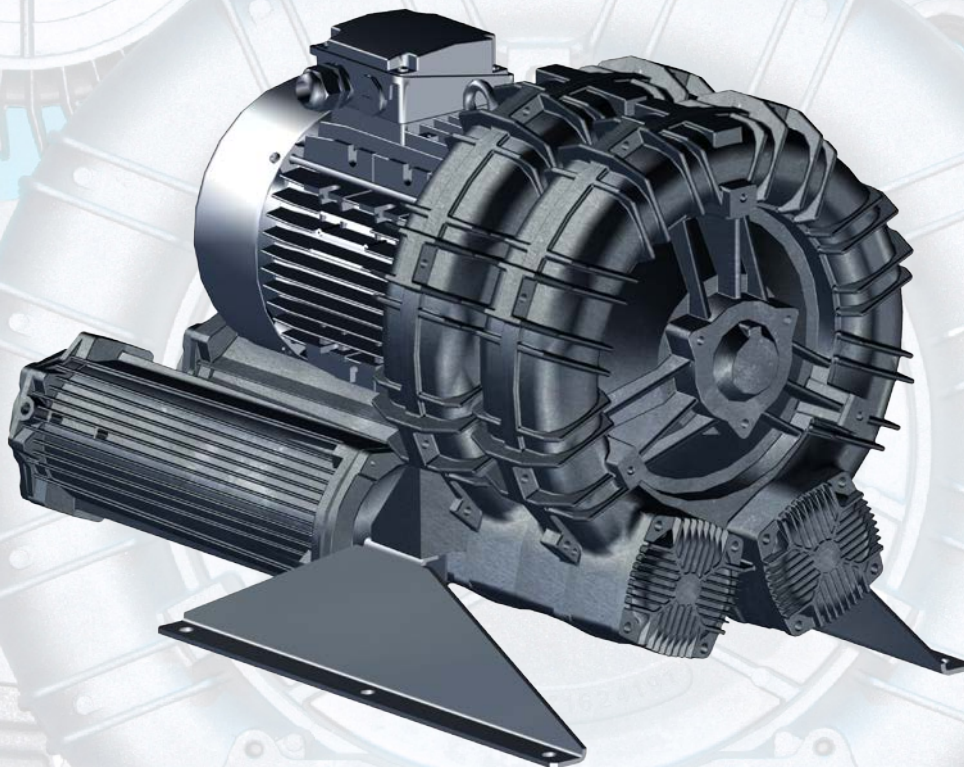

Data sheet

LATERAL CHANNEL BLOWER-EXHAUSTER

PRESSURE

Model	N 2900 rpm [kW]	N 3500 rpm [kW]	Q max 2900 rpm [m³/h]	Q max 3500 rpm [m³/h]	ΔP max 2900 rpm [hPa] (mbar)	ΔP max 3500 rpm [hPa] (mbar)	Leq ¹ 2900 rpm (Lp) [dB(A)]	Leq ¹ 3500 rpm (Lp) [dB(A)]	Weight ² max [kg]
K05-TS	2,2	2,55	408	493	115	90	70	72	40,5
	3	3,45	408	493	175	140	71,5	73,5	44,5
	4	4,6	408	493	250	210	73,5	75,5	48
K06-TS	4	4,6	562	679	130	100	75,2	77,2	56
	5,5	6,3	562	679	200	175	75,5	77,5	66,5
	7,5	8,7	562	679	300	275	75,8	77,8	71,5
K07-TS	5,5	6,3	827	998	150	110	81,9	83,9	88
	7,5	8,7	827	998	225	200	82,2	84,2	93
	9,2	10,6	827	998	275	250	82,5	84,5	102,5
	11	12,7	827	998	350	300	82,8	84,8	103,5
	-	17,4	827	998	-	450	-	85,1	19,5
K08-TS	5,5	6,3	1006	1214	100	60	78,8	80,8	91,5
	7,5	8,7	1006	1214	160	120	78,9	80,9	96,5
	9,2	10,6	1006	1214	210	170	80,1	82,1	106
	11	12,7	1006	1214	260	220	81,3	83,3	107
	15	17,4	1006	1214	380	325	82,5	84,5	113
K09-TS	9,2	10,6	1325	1599	145	110	79	81	116
	11	12,7	1325	1599	190	150	81	83	117
	15	17,4	1325	1599	270	240	83	85	128
	18,5	21,5	1325	1599	360	275	85	87	158
K10-TS	11	12,7	1539	1857	160	125	85,8	87,8	122
	15	17,4	1539	1857	225	180	86,1	88,1	133
	18,5	21,5	1539	1857	275	260	86,4	88,4	163
K11-TS	11	-	1764	2129	100	-	86	-	135
	15	17,4	1764	2129	160	105	86,7	88,7	146
	18,5	21,5	1764	2129	220	165	87,4	89,4	176
	22 ^(*)	25,5	1764	2129	275	220	88	90	186,5
K12-TS	18,5	-	1985	2395	150	-	88	-	175
	22	25,5	1985	2395	200	140	88,6	90,6	185,5

(*) K11-TS 22 kW vertical assembly only

INSTALLATION

- For proper use, the blower should be equipped with INLET FILTER and SAFETY VALVE; other accessories available on request
- Ambient temperature from -15° to +40°C (+5° to +104° F)
- Specifications subject to change without notice
- Before installation read carefully all instructions

¹ Noise measured at 1 m distance with inlet and outlet ports piped, in accordance to ISO 3744

² Value refers to the weight of the machine with 3 Phase motor if MOR range, without motor if GOR or GVR range.

N: Installed motor power

Q: Flow rate

P: Differential pressure

Leq: Noise

PRESSURE

2900 rpm (50 Hz)

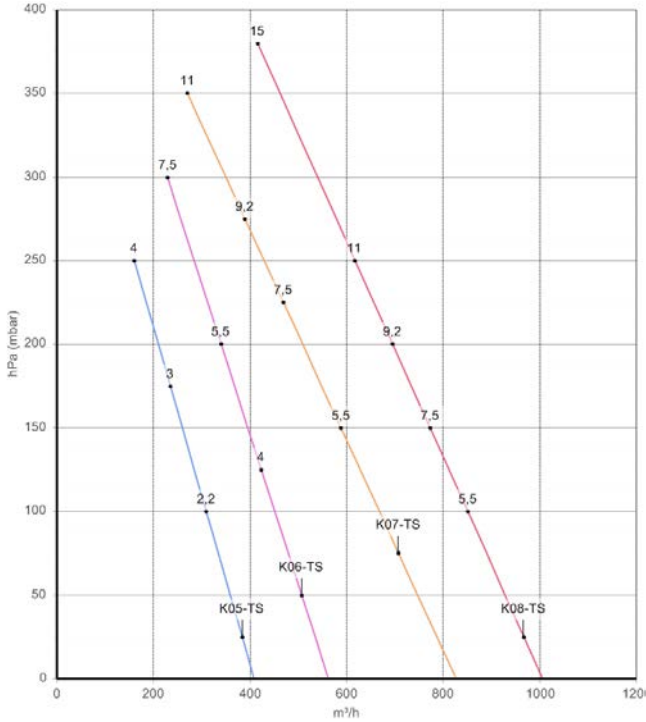

3500 rpm (60 Hz)

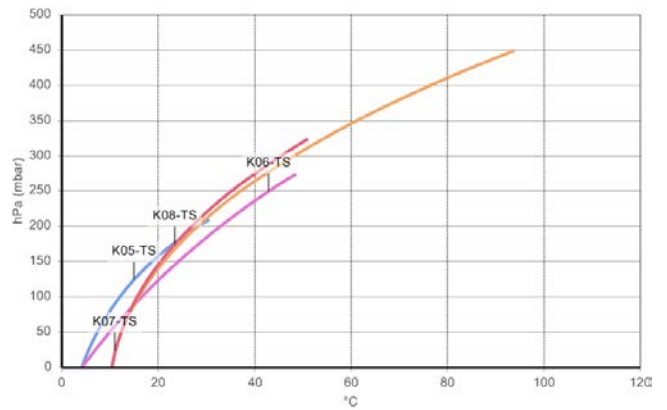
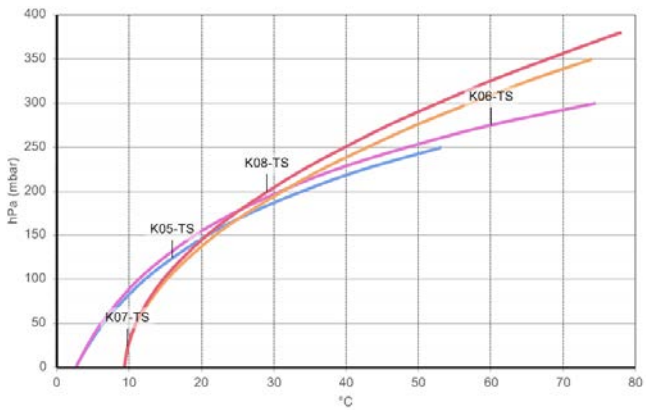
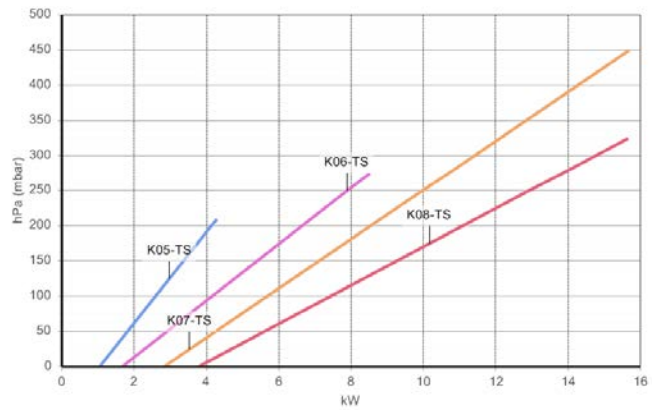
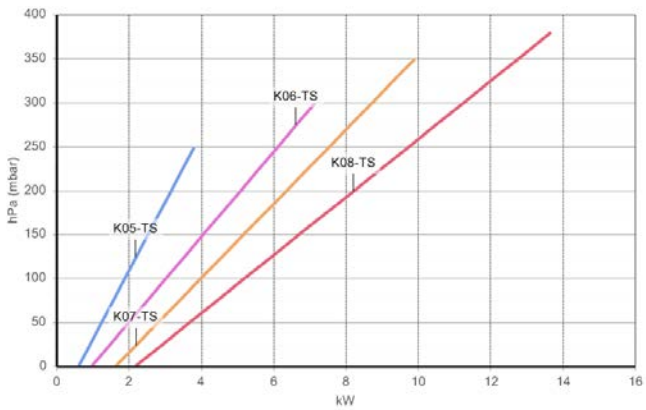
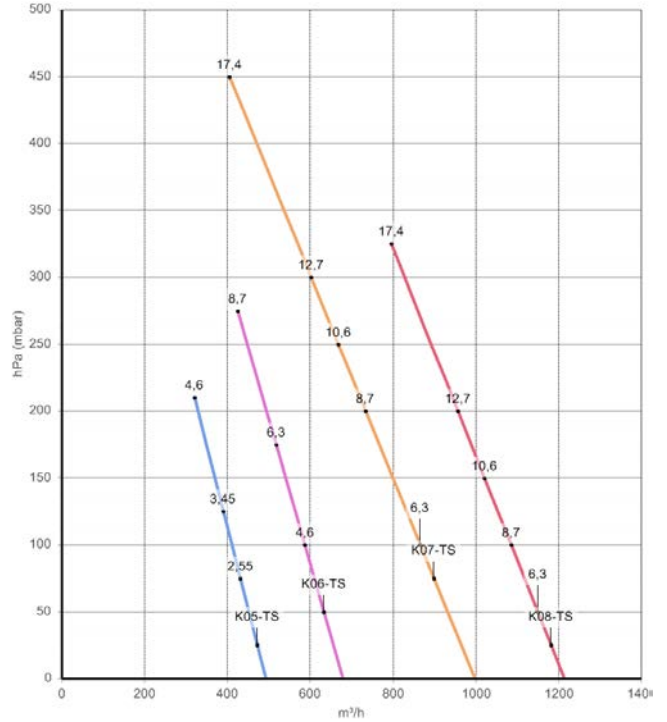

Curves refer to air at 20°C (68° F) temperature and 1013 mbar (29.92 In Hg) atmospheric pressure (abs) measured at inlet port.
Values for flow, power consumption and temperature rise: ±10% tolerance
Data can change without prior notice

VACUUM

Model	N 2900 rpm [kW]	N 3500 rpm [kW]	Q max 2900 rpm [m ³ /h]	Q max 3500 rpm [m ³ /h]	ΔP max 2900 rpm [hPa] (mbar)	ΔP max 3500 rpm [hPa] (mbar)	Leq ¹ 2900 rpm (Lp) [dB(A)]	Leq ¹ 3500 rpm (Lp) [dB(A)]	Weight ² max [kg]
K05-TS	2,2	2,55	408	493	115	90	69,6	71,6	40,5
	3	3,45	408	493	175	140	71,1	73,1	44,5
	4	4,6	408	493	225	210	73,1	75,1	48
K06-TS	4	4,6	562	679	130	100	74,8	76,8	56
	5,5	6,3	562	679	200	175	75,1	77,1	66,5
	7,5	8,7	562	679	250	250	75,4	77,4	71,5
K07-TS	5,5	6,3	827	998	150	110	82,5	84,5	88
	7,5	8,7	827	998	225	200	82,8	84,8	93
	9,2	10,6	827	998	275	250	83,1	85,1	102,5
	11	12,7	827	998	300	300	83,4	85,4	103,5
	-	17,4	827	998	-	350	-	85,7	19,5
K08-TS	5,5	6,3	1006	1214	100	60	78,9	80,9	91,5
	7,5	8,7	1006	1214	160	120	79,2	81,2	96,5
	9,2	10,6	1006	1214	210	170	80,7	82,7	106
	11	12,7	1006	1214	260	220	80,9	82,9	107
K09-TS	15	17,4	1006	1214	325	325	81,1	83,1	113
	9,2	10,6	1325	1599	145	110	80,1	82,1	116
	11	12,7	1325	1599	190	150	82,2	84,2	117
	15	17,4	1325	1599	270	240	84,1	86,1	128
	18,5	21,5	1325	1599	325	275	86,1	88,1	158
K10-TS	11	12,7	1539	1857	160	125	87,1	89,1	122
	15	17,4	1539	1857	225	180	87,4	89,4	133
	18,5	21,5	1539	1857	275	260	87,7	89,7	163
K11-TS	11	-	1764	2129	100	-	87,3	-	135
	15	17,4	1764	2129	160	105	88	90	146
	18,5	21,5	1764	2129	220	165	88,7	90,7	176
	22 ^(*)	25,5	1764	2129	275	220	89,3	91,3	186,5
K12-TS	18,5	-	1985	2395	150	-	89,3	-	175
	22	25,5	1985	2395	200	140	89,9	91,9	185,5

(*) K11-TS 22 kW vertical assembly only

¹ Noise measured at 1 m distance with inlet and outlet ports piped, in accordance to ISO 3744.

² Value refers to the weight of the machine with 3 Phase motor if MOR range, without motor if GOR or GVR range.

³ Electric motor's construction form

N: Installed power

Q: Flow rate

P: Differential pressure

Leq: Noise

VACUUM

2900 rpm (50 Hz)

3500 rpm (60 Hz)

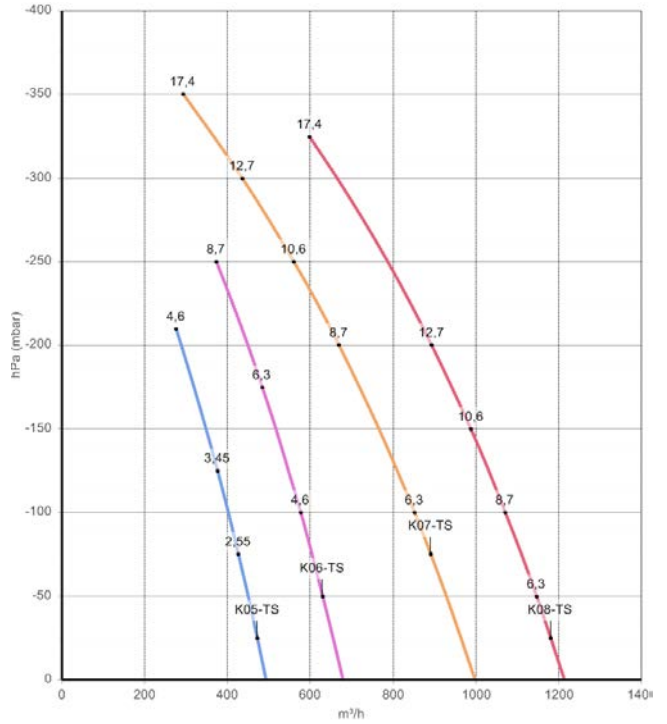
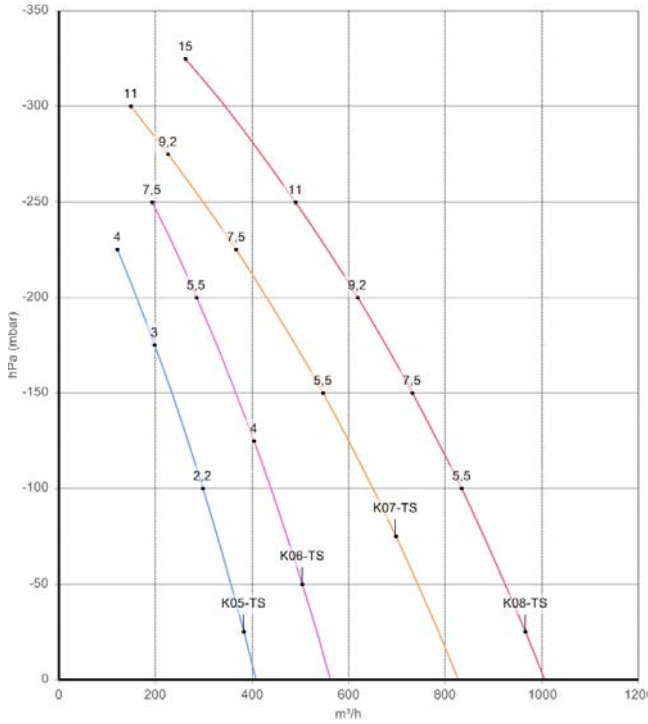

FLOW RATE

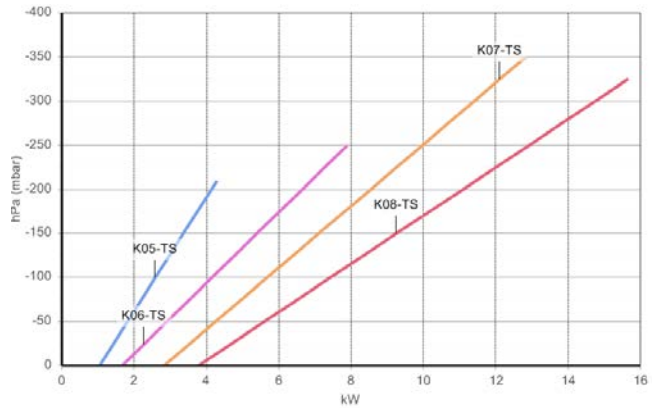
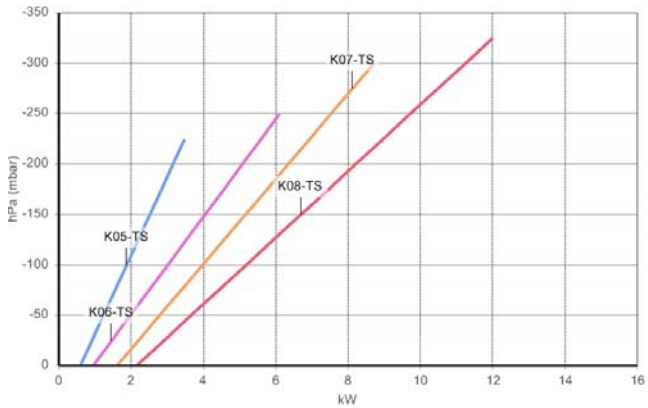

ABSORBED POWER

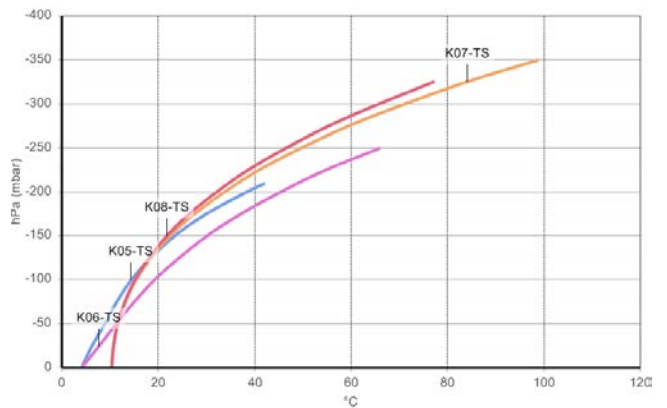
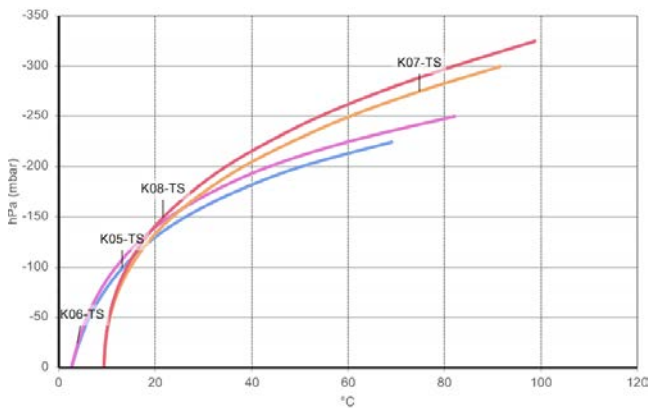

TEMPERATURE INCREASE

Curves refer to air at 20°C (68° F) temperature, measured at inlet port and 1013 mbar (29.92 In Hg) atmospheric backpressure (abs).
Values for flow, power consumption and temperature rise: ± 10% tolerance
Data can change without prior notice.

VACUUM

2900 rpm (50 Hz)

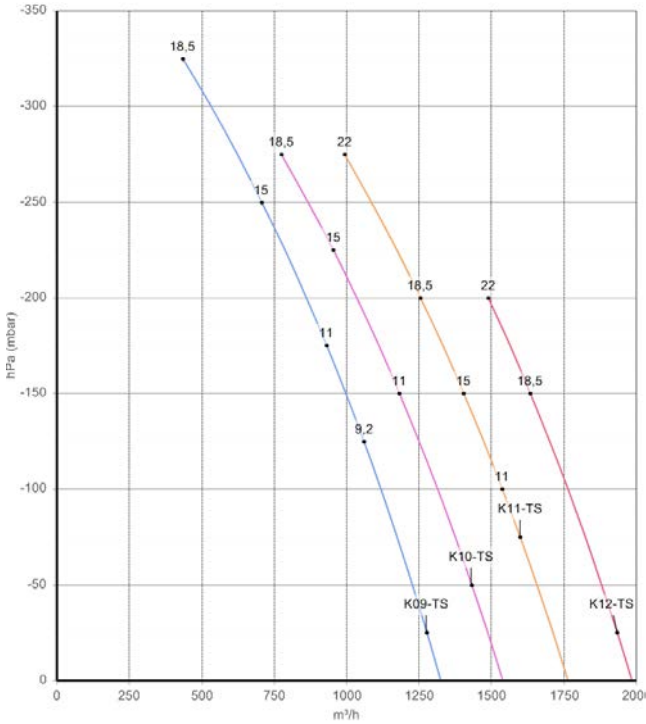

3500 rpm (60 Hz)

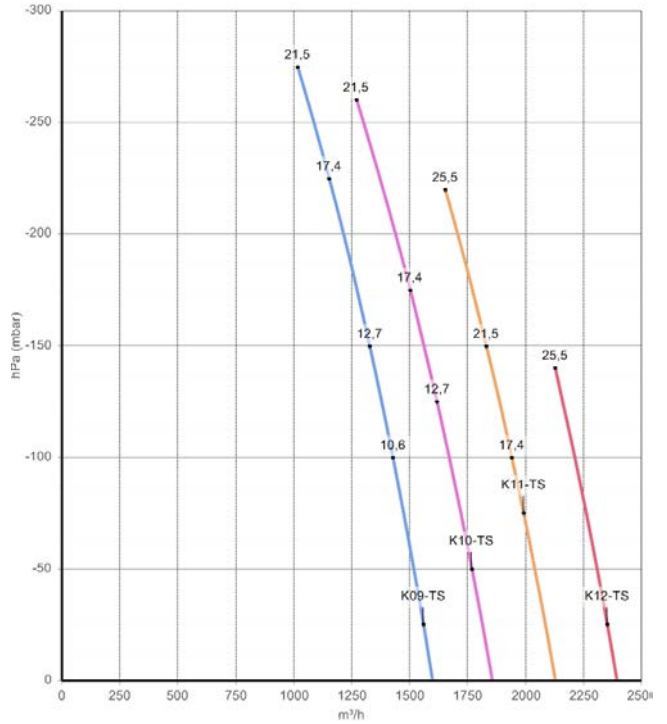

FLOW RATE

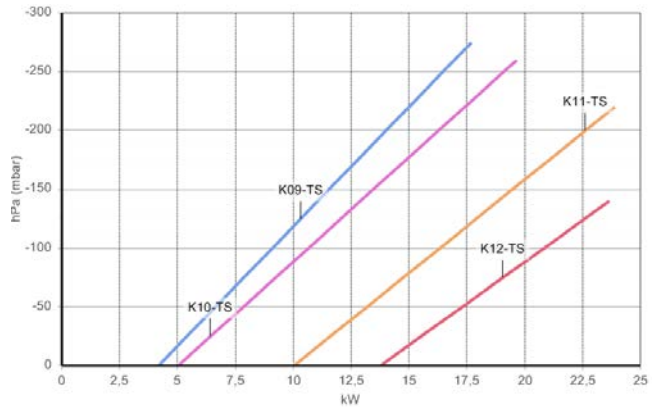
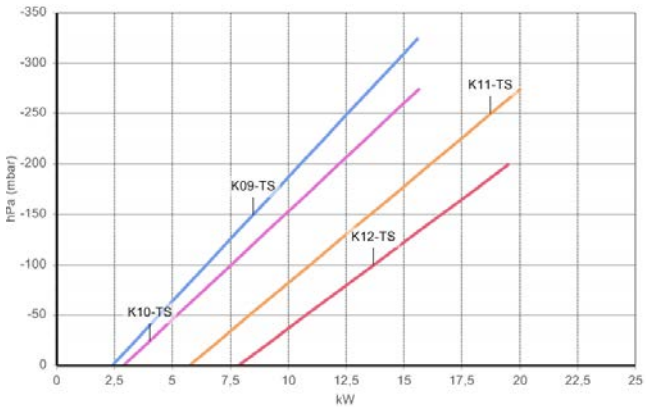

ABSORBED POWER

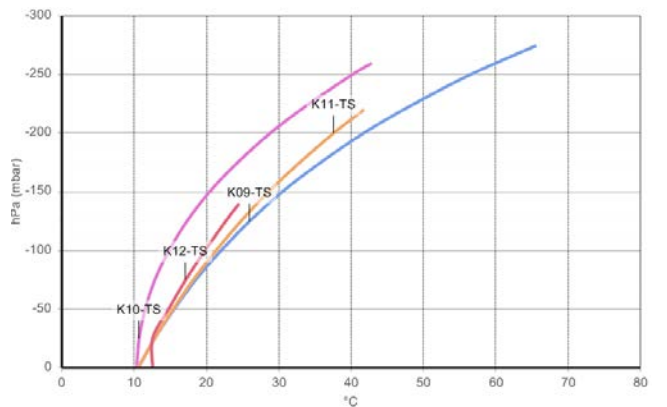
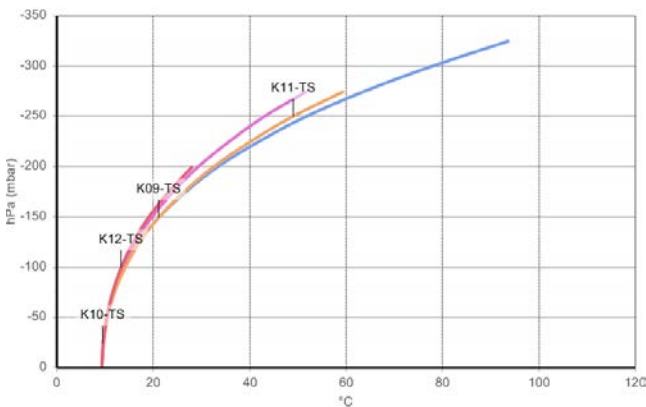

TEMPERATURE INCREASE

Curves refer to air at 20°C (68° F) temperature, measured at inlet port and 1013 mbar (29.92 In Hg) atmospheric backpressure (abs).
Values for flow, power consumption and temperature rise: ± 10% tolerance
Data can change without prior notice.

DIMENSIONS (K05-TS/K06-TS/K07-TS/K08-TS/K09-TS/K10-TS/K11-TS/K12-TS)

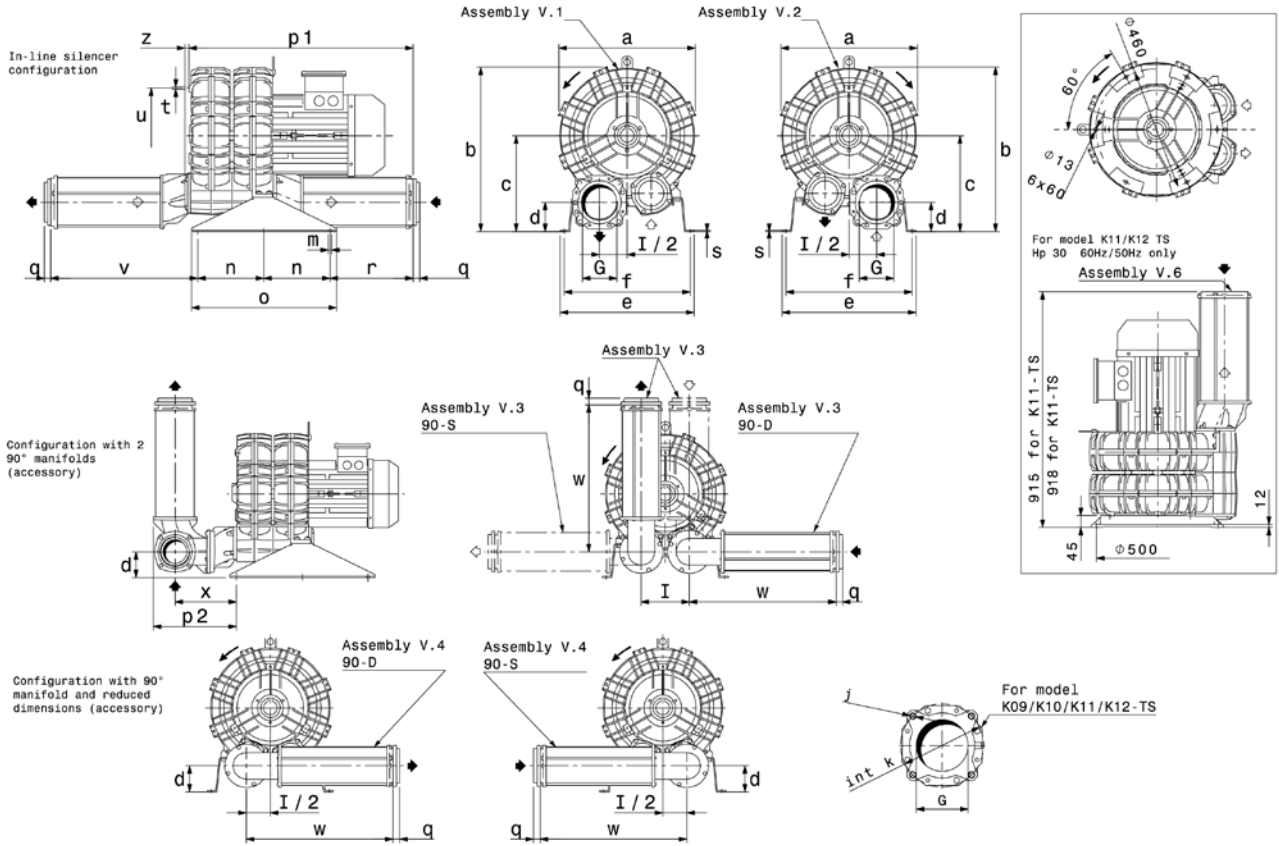

Dimensions in mm - FOR REFERENCE ONLY

Model	a	b	c	d	e	f	G	H
K05-TS	327	422	258	77	404	374	G 3"	485
K06-TS	376	450	262	75	404	374	G 3"	580
K07-TS	424	531	319	98	468	438	G 4"	620
K08-TS	457	548	319	98	478	448	G 4"	620
K09-TS	492	610	365	112	508	478	130	745
K10-TS	516	623	365	112	508	478	130	745
K11-TS	542	650	380	106	540	510	130	800
K12-TS	548	652	380	106	540	510	130	803

Model	i	j	k	m	n	o	p1	p2	q
K05-TS	150	-	-	13	300	345	634	249	25
K06-TS	155	-	-	13	300	345	662	268	25
K07-TS	182	-	-	13	250	550	802	315	25
K08-TS	182	-	-	13	250	550	802	315	25
K09-TS	210	M16	210	13	250	550	850	447	-
K10-TS	210	M16	210	13	250	550	850	447	-
K11-TS	228	M16	210	13	250	550	870	462	-
K12-TS	228	M16	210	13	250	550	873	462	-

Model	r	s	t	u	v	w	x	z
K05-TS	328	4	M8	200	436	481	176	19
K06-TS	335	4	M8	240	455	481	195	19
K07-TS	299	5	M8	295	522	581	276	16
K08-TS	299	5	M8	310	522	581	276	16
K09-TS	315	5	M8	360	558	608	337	16
K10-TS	315	5	M8	360	558	608	337	16
K11-TS	320	5	M8	390	573	608	352	16
K12-TS	320	5	M8	390	573	608	352	16

En Chile: **VERSOL LTDA.** www.versol.cl versol@versol.cl

Sopladores y Bombas de Vacío Lóbulos - Roots - De Paletas - Pistón y Membrana - Canal Lateral - De Garra - Limpiafosas - Difusores Aire - Centrales de Vacío - Serv. Técnico Autorizado - Rep. y Accesorios Cabinas Acústicas - Repuestos de Molinería - Aspiradoras de Granos y Polvos - Transportes Mecánicos y Neumático de Sólidos - Silos de Tela Tubería de Aspiración y Bajada - Sistema Levantador de Sacos - Imanes Soluciones en Neumática - Válvulas Rotativas (esclusas).

Los Manzanos # 2568 Huertos de La Pintana - La Pintana
Fonos (56-2) 27805528 y 27805530